

REVISIONS			
REV	DESCRIPTION	SIGN	DATE

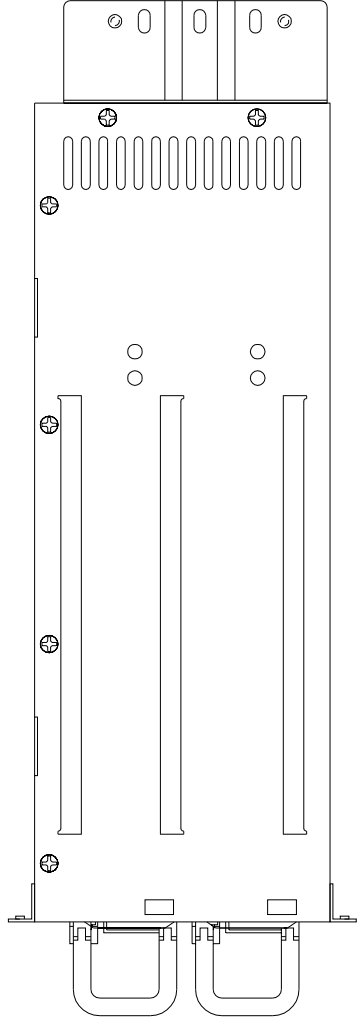

TOLERANCES	MATERIAL	UNIT	MM	PART NO
.X = +/- 0.25	REMARK	SCLAE	1 : 1	MODEL
.XX = +/- 0.100	APPD	CKD	DRAWN	DWG NO.
		SHEET	DF	DATE

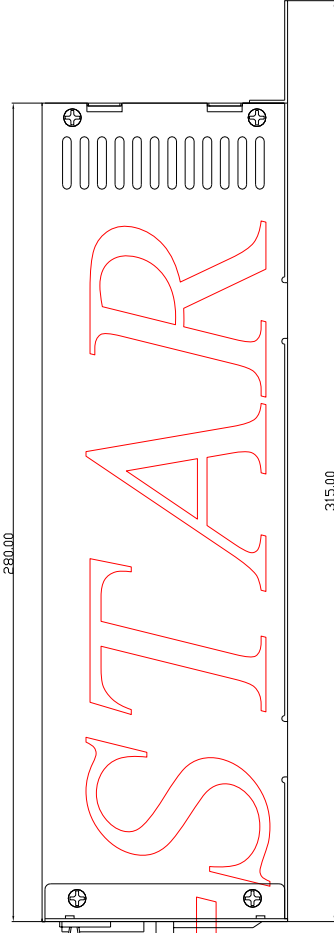
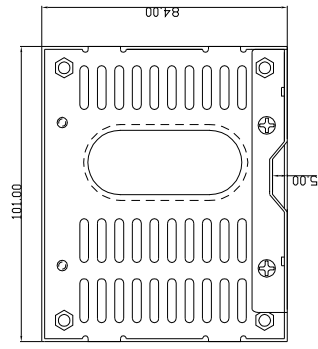
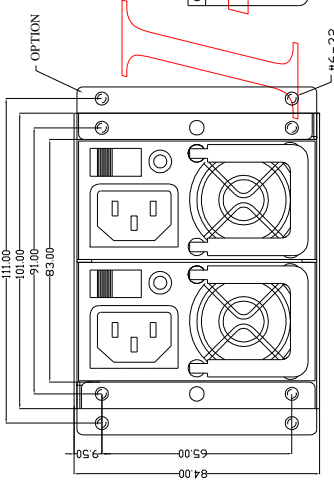
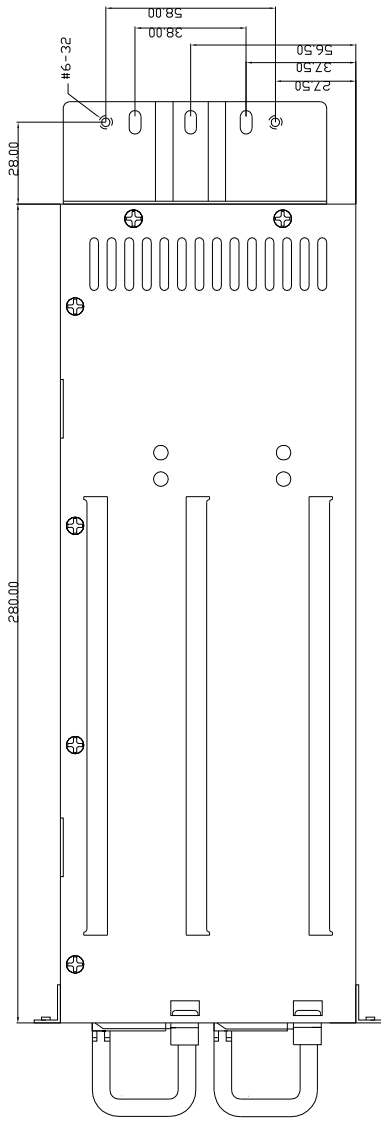
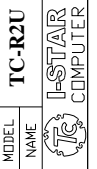

TC-R2U

PINOUPS OF CONNECTORS

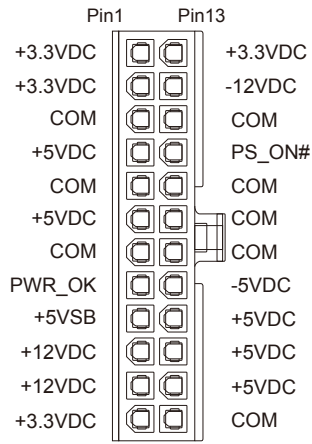

Main Power Connector

- | | | |
|----------------|-----------------|-------------|
| +12V = yellow | +5VSB = brown | -5V = white |
| +5V = red | PS_ON# = gray | -12V = blue |
| +3.3V = purple | PWR_OK = orange | COM = black |

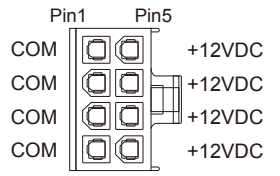

+12V 8P Power Connector

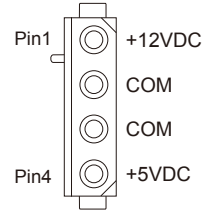

Peripheral Power Connector

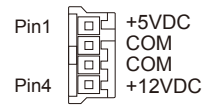

Floppy Drive Power Connector

