

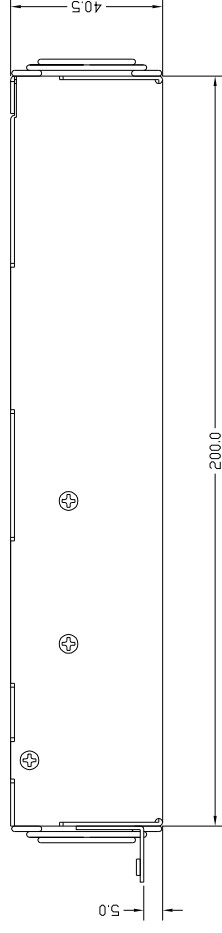

REVISIONS

REV	DESCRIPTION	SIGN	DATE

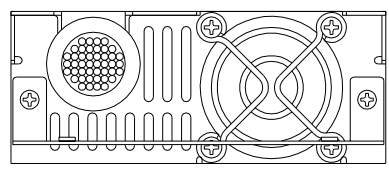
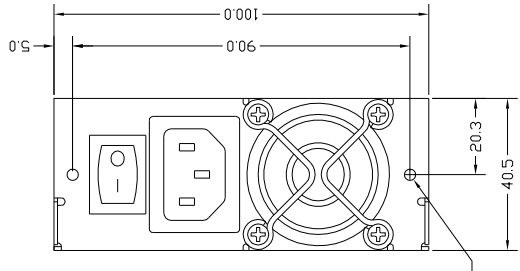
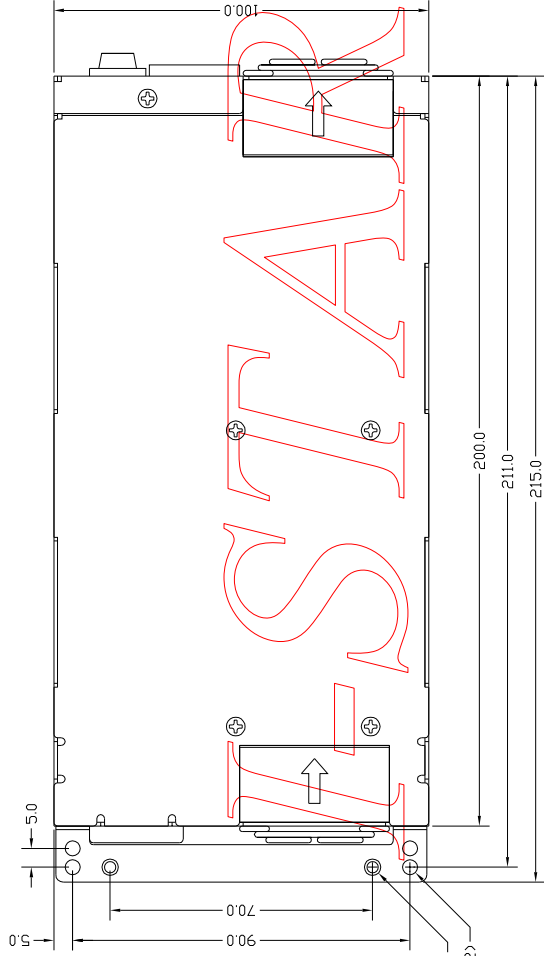
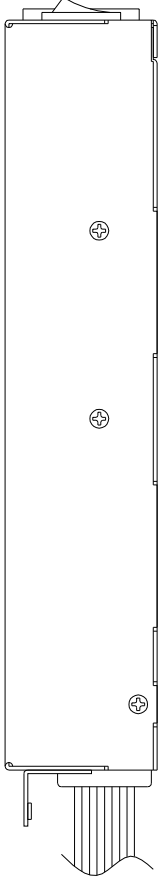

TOLERANCES		MATERIAL	UNIT	PART NO
.X = +/-	0.25	REMARK	SCLAE	1:1
.XX = +/-	0.100	APPD	DWG NO.	
		CKD	SHEET	DF
			DATE	/ /

**TC-1UXX**



# PINOUPS OF CONNECTORS

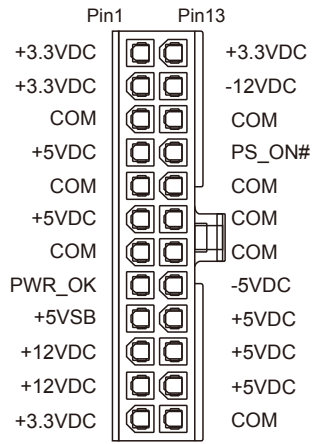

Main Power Connector

- |                |                 |             |
|----------------|-----------------|-------------|
| +12V = yellow  | +5VSB = brown   | -5V = white |
| +5V = red      | PS_ON# = gray   | -12V = blue |
| +3.3V = purple | PWR_OK = orange | COM = black |

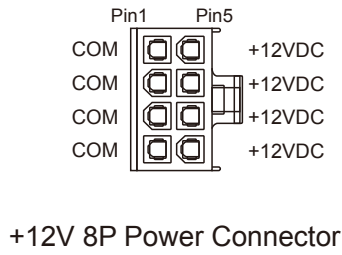

+12V 8P Power Connector

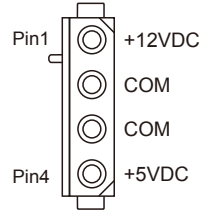

Peripheral Power Connector

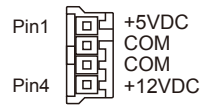

Floppy Drive Power Connector

